

# CD74HC4067, CD74HCT4067

## High-Speed CMOS Logic 16-Channel Analog Multiplexer/Demultiplexer

### Features

- Wide Analog Input Voltage Range
- Low "ON" Resistance
  - $V_{CC} = 4.5V$  . . . . .  $70\Omega$  (Typ)
  - $V_{CC} = 6V$  . . . . .  $60\Omega$  (Typ)
- Fast Switching and Propagation Speeds
- "Break-Before-Make" Switching. . . . . 6ns (Typ) at 4.5V
- Available in Both Narrow and Wide-Body Plastic Packages
- Fanout (Over Temperature Range)
  - Standard Outputs . . . . . 10 LSTTL Loads
  - Bus Driver Outputs . . . . . 15 LSTTL Loads
- Wide Operating Temperature Range . . . -55°C to 125°C
- Balanced Propagation Delay and Transition Times
- Significant Power Reduction Compared to LSTTL Logic ICs
- HC Types
  - 2V to 6V Operation
  - High Noise Immunity:  $N_{IL} = 30\%$ ,  $N_{IH} = 30\%$  of  $V_{CC}$

at  $V_{CC} = 5V$

- HCT Types
  - 4.5V to 5.5V Operation
  - Direct LSTTL Input Logic Compatibility,  $V_{IL} = 0.8V$  (Max),  $V_{IH} = 2V$  (Min)
  - CMOS Input Compatibility,  $I_I \leq 1\mu A$  at  $V_{OL}$ ,  $V_{OH}$

### Description

The Harris CD74HC4067 and CD74HCT4067 are digitally controlled analog switches which utilize silicon-gate CMOS technology to achieve operating speeds similar to LSTTL with the low power consumption of standard CMOS integrated circuits.

These analog multiplexers/demultiplexers control analog voltages that may vary across the voltage supply range. They are bidirectional switches thus allowing any analog input to be used as an output and visa-versa. The switches have low "on" resistance and low "off" leakages. In addition, these devices have an enable control which when high will disable all switches to their "off" state.

### Ordering Information

PART NUMBER	TEMP. RANGE (°C)	PACKAGE	PKG. NO.
-------------	------------------	---------	----------

### Pinout

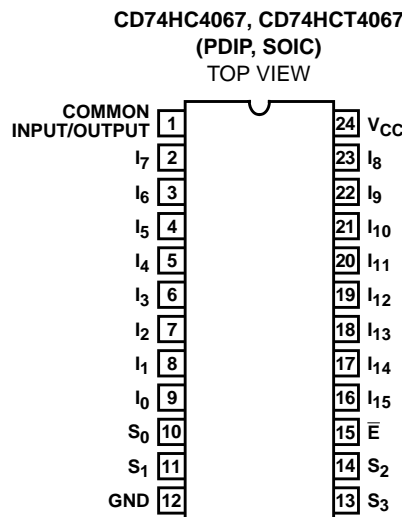

CD74HC4067, CD74HCT4067

Functional Diagram

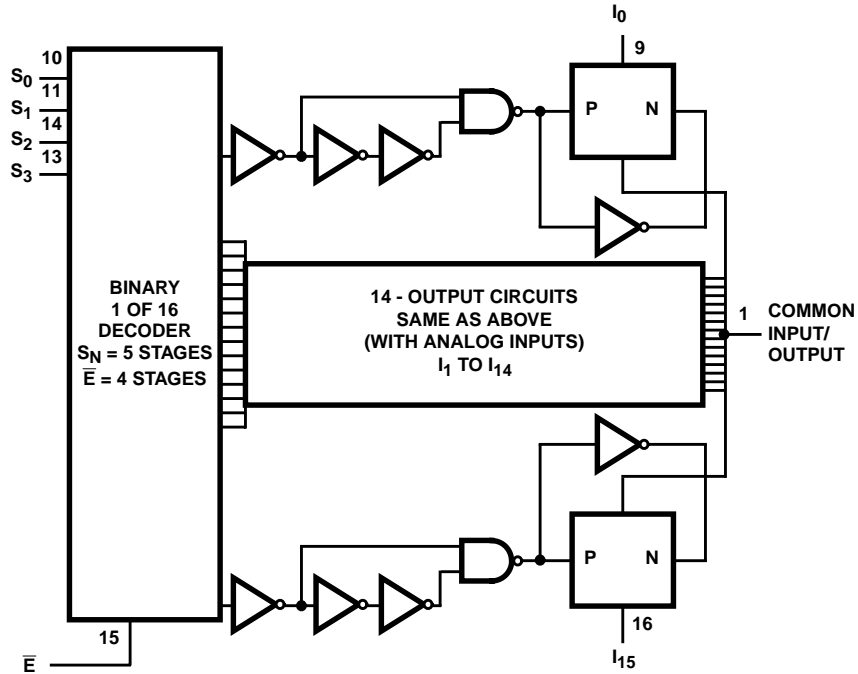

TRUTH TABLE

S <sub>0</sub>	S <sub>1</sub>	S <sub>2</sub>	S <sub>3</sub>	E-bar	SELECTED CHANNEL
X	X	X	X	1	None
0	0	0	0	0	0
1	0	0	0	0	1
0	1	0	0	0	2
1	1	0	0	0	3
0	0	1	0	0	4
1	0	1	0	0	5
0	1	1	0	0	6
1	1	1	0	0	7
0	0	0	1	0	8
1	0	0	1	0	9
0	1	0	1	0	10
1	1	0	1	0	11
0	0	1	1	0	12
1	0	1	1	0	13
0	1	1	1	0	14
1	1	1	1	0	15

NOTE:

H = High Level

L = Low Level

X = Don't Care

# CD74HC4067, CD74HCT4067

## Absolute Maximum Ratings

DC Supply Voltage, $V_{CC}$ (Voltages Referenced to Ground) .....	-0.5V to 7V
DC Input Diode Current, $I_{IK}$ For $V_I < -0.5V$ or $V_I > V_{CC} + 0.5V$ .....	$\pm 20mA$
DC Drain Current, $I_O$ For $-0.5V < V_O < V_{CC} + 0.5V$ .....	$\pm 25mA$
DC Output Diode Current, $I_{OK}$ For $V_O < -0.5V$ or $V_O > V_{CC} + 0.5V$ .....	$\pm 20mA$
DC Output Source or Sink Current per Output Pin, $I_O$ For $V_O > -0.5V$ or $V_O < V_{CC} + 0.5V$ .....	$\pm 25mA$
DC $V_{CC}$ or Ground Current, $I_{CC}$ .....	$\pm 50mA$

## Thermal Information

Thermal Resistance (Typical, Note 3)	$\theta_{JA}$ ( $^{\circ}C/W$ )
PDIP Package .....	60
SOIC Package .....	75
Maximum Junction Temperature (Hermetic Package or Die) . . .	$175^{\circ}C$
Maximum Junction Temperature (Plastic Package) .....	$150^{\circ}C$
Maximum Storage Temperature Range .....	$-65^{\circ}C$ to $150^{\circ}C$
Maximum Lead Temperature (Soldering 10s) .....	$300^{\circ}C$ (SOIC - Lead Tips Only)

## Operating Conditions

Temperature Range, $T_A$ .....	$-55^{\circ}C$ to $125^{\circ}C$
Supply Voltage Range, $V_{CC}$	
HC Types .....	$.2V$ to $6V$
HCT Types .....	$.4.5V$ to $5.5V$
DC Input or Output Voltage, $V_I, V_O$ .....	$0V$ to $V_{CC}$
Input Rise and Fall Time	
$2V$ .....	$1000ns$ (Max)
$4.5V$ .....	$500ns$ (Max)
$6V$ .....	$400ns$ (Max)

CAUTION: Stresses above those listed in "Absolute Maximum Ratings" may cause permanent damage to the device. This is a stress only rating and operation of the device at these or any other conditions above those indicated in the operational sections of this specification is not implied.

### NOTE:

- $\theta_{JA}$  is measured with the component mounted on an evaluation PC board in free air.

## DC Electrical Specifications

PARAMETER	SYMBOL	TEST CONDITIONS		$V_{CC}$ (V)	25°C			-40°C TO 85°C		-55°C TO 125°C		UNITS
		$V_I$ (V)	$V_{IS}$ (V)		MIN	TYP	MAX	MIN	MAX	MIN	MAX	
<b>HC TYPES</b>												
High Level Input Voltage	$V_{IH}$	-	-	2	1.5	-	-	1.5	-	1.5	-	V
				4.5	3.15	-	-	3.15	-	3.15	-	V
				6	4.2	-	-	4.2	-	4.2	-	V
Low Level Input Voltage	$V_{IL}$	-	-	2	-	-	0.5	-	0.5	-	0.5	V
				4.5	-	-	1.35	-	1.35	-	1.35	V
				6	-	-	1.8	-	1.8	-	1.8	V
Maximum "ON" Resistance $I_O = 1mA$	$R_{ON}$	$V_{CC}$ or GND	$V_{CC}$ or GND	4.5	-	70	160	-	200	-	240	$\Omega$
				6	-	60	140	-	175	-	210	$\Omega$
		$V_{CC}$ to GND	$V_{CC}$ to GND	4.5	-	90	180	-	225	-	270	$\Omega$
				6	-	80	160	-	200	-	240	$\Omega$
Maximum "ON" Resistance Between Any Two Switches	$\Delta R_{ON}$	-	-	4.5	-	10	-	-	-	-	-	$\Omega$
				6	-	8.5	-	-	-	-	-	$\Omega$
Switch "Off" Leakage Current 16 Channels	$I_{IZ}$	$\bar{E} = V_{CC}$	$V_{CC}$ or GND	6	-	-	$\pm 0.8$	-	$\pm 8$	-	$\pm 8$	$\mu A$
Logic Input Leakage Current	$I_I$	$V_{CC}$ or GND	-	6	-	-	$\pm 0.1$	-	$\pm 1$	-	$\pm 1$	$\mu A$
Quiescent Device Current $I_O = 0mA$	$I_{CC}$	$V_{CC}$ or GND	-	6	-	-	8	-	80	-	160	$\mu A$

## CD74HC4067, CD74HCT4067

### DC Electrical Specifications (Continued)

PARAMETER	SYMBOL	TEST CONDITIONS		V <sub>CC</sub> (V)	25°C			-40°C TO 85°C		-55°C TO 125°C		UNITS
		V <sub>I</sub> (V)	V <sub>IS</sub> (V)		MIN	TYP	MAX	MIN	MAX	MIN	MAX	
<b>HCT TYPES</b>												
High Level Input Voltage	V <sub>IH</sub>	-	-	4.5	2	-	-	2	-	2	-	V
Low Level Input Voltage	V <sub>IL</sub>	-	-	4.5	-	-	0.8	-	0.8	-	0.8	V
Maximum "ON" Resistance I <sub>O</sub> = 1mA	R <sub>ON</sub>	V <sub>CC</sub> or GND	V <sub>CC</sub> or GND	4.5	-	70	160	-	200	-	240	Ω
		V <sub>CC</sub> to GND	V <sub>CC</sub> to GND	4.5	-	90	180	-	225	-	270	Ω
Maximum "ON" Resistance Between Any Two Switches	ΔR <sub>ON</sub>	-	-	4.5	-	10	-	-	-	-	-	Ω
Switch "Off" Leakage Current 16 Channels	I <sub>Iz</sub>	$\bar{E} = V_{CC}$	V <sub>CC</sub> or GND	6	-	-	±0.8	-	±8	-	±8	μA
Logic Input Leakage Current	I <sub>I</sub>	V <sub>CC</sub> or GND (Note 5)	-	6	-	-	±0.1	-	±1	-	±1	μA
Quiescent Device Current	I <sub>CC</sub>	V <sub>CC</sub> or GND	-	6	-	-	8	-	80	-	160	μA
Additional Quiescent Device Current Per Input Pin: 1 Unit Load	ΔI <sub>CC</sub> (Note 4)	V <sub>CC</sub> -2.1	-	-	-	100	360	-	450	-	490	μA

**NOTES:**

4. For dual-supply systems theoretical worst case (V<sub>I</sub> = 2.4V, V<sub>CC</sub> = 5.5V) specification is 1.8mA.
5. Any voltage between V<sub>CC</sub> and GND.

### HCT Input Loading Table

INPUT	UNIT LOADS
S <sub>0</sub> - S <sub>3</sub>	0.5
$\bar{E}$	0.3

NOTE: Unit Load is ΔI<sub>CC</sub> limit specified in DC Electrical Specifications table, e.g., 360μA max at 25°C.

### Switching Specifications Input t<sub>r</sub>, t<sub>f</sub> = 6ns

PARAMETER	SYMBOL	TEST CONDITIONS	V <sub>CC</sub> (V)	25°C			-40°C TO 85°C		-55°C TO 125°C		UNITS
				MIN	TYP	MAX	MIN	MAX	MIN	MAX	
<b>HC TYPES</b>											
Propagation Delay Time Switch In to Out	t <sub>PLH</sub> , t <sub>PHL</sub>	C <sub>L</sub> = 50pF	2	-	-	75	-	95	-	110	ns
			4.5	-	-	15	-	19	-	22	ns
			6	-	-	13	-	16	-	19	ns
		C <sub>L</sub> = 15pF	5	-	6	-	-	-	-	-	ns
Switch Turn On $\bar{E}$ to Out	t <sub>PZH</sub> , t <sub>PZL</sub>	C <sub>L</sub> = 50pF	2	-	-	275	-	345	-	415	ns
			4.5	-	-	55	-	69	-	83	ns
			6	-	-	47	-	59	-	71	ns
		C <sub>L</sub> = 15pF	5	-	23	-	-	-	-	-	ns

**CD74HC4067, CD74HCT4067**

**Switching Specifications** Input  $t_r, t_f = 6\text{ns}$  (Continued)

PARAMETER	SYMBOL	TEST CONDITIONS	V <sub>CC</sub> (V)	25°C			-40°C TO 85°C		-55°C TO 125°C		UNITS
				MIN	TYP	MAX	MIN	MAX	MIN	MAX	
Switch Turn On Sn to Out	t <sub>PZH</sub> , t <sub>PZL</sub>	C <sub>L</sub> = 50pF	2	-	-	300	-	375	-	450	ns
			4.5	-	-	60	-	75	-	90	ns
			6	-	-	51	-	64	-	76	ns
		C <sub>L</sub> = 15pF	5	-	25	-	-	-	-	-	ns
Switch Turn Off Ē to Out	t <sub>PHZ</sub> , t <sub>PLZ</sub>	C <sub>L</sub> = 50pF	2	-	-	275	-	345	-	415	ns
			4.5	-	-	55	-	69	-	83	ns
			6	-	-	47	-	59	-	71	ns
		C <sub>L</sub> = 15pF	5	-	23	-	-	-	-	-	ns
Switch Turn Off Sn to Out	t <sub>PHZ</sub> , t <sub>PLZ</sub>	C <sub>L</sub> = 50pF	2	-	-	290	-	365	-	435	ns
			4.5	-	-	58	-	73	-	87	ns
			6	-	-	49	-	62	-	74	ns
		C <sub>L</sub> = 50pF	5	-	21	-	-	-	-	-	ns
Input (Control) Capacitance	C <sub>I</sub>	-	-	-	10	-	10	-	10	pF	
Power Dissipation Capacitance (Notes 6, 7)	C <sub>PD</sub>	-	5	-	93	-	-	-	-	pF	
<b>HCT TYPES</b>											
Propagation Delay Time Switch In to Out	t <sub>PLH</sub> , t <sub>PHL</sub>	C <sub>L</sub> = 50pF	4.5	-	-	15	-	19	-	22	ns
		C <sub>L</sub> = 15pF	5	-	6	-	-	-	-	-	ns
Switch Turn On Ē to Out	t <sub>PZH</sub> , t <sub>PZL</sub>	C <sub>L</sub> = 50pF	4.5	-	-	60	-	75	-	90	ns
		C <sub>L</sub> = 15pF	5	-	25	-	-	-	-	-	ns
Switch Turn On Sn to Out	t <sub>PZH</sub> , t <sub>PZL</sub>	C <sub>L</sub> = 50pF	4.5	-	-	60	-	75	-	90	ns
		C <sub>L</sub> = 15pF	5	-	25	-	-	-	-	-	ns
Switch Turn Off Ē to Out	t <sub>PHZ</sub> , t <sub>PLZ</sub>	C <sub>L</sub> = 50pF	4.5	-	-	55	-	69	-	83	ns
		C <sub>L</sub> = 15pF	5	-	23	-	-	-	-	-	ns
Switch Turn Off Sn to Out	t <sub>PHZ</sub> , t <sub>PLZ</sub>	C <sub>L</sub> = 50pF	4.5	-	-	58	-	73	-	87	ns
		C <sub>L</sub> = 15pF	5	-	21	-	-	-	-	-	ns
Input (Control) Capacitance	C <sub>I</sub>	-	-	-	10	-	10	-	10	pF	
Power Dissipation Capacitance (Notes 6, 7)	C <sub>PD</sub>	-	5	-	96	-	-	-	-	pF	

**NOTES:**

6. C<sub>PD</sub> is used to determine the dynamic power consumption, per package.

7.  $P_D = C_{PD} V_{CC}^2 f_i + \sum (C_L + C_S) V_{CC}^2 f_o$  where  $f_i$  = input frequency,  $f_o$  = output frequency,  $C_L$  = output load capacitance,  $C_S$  = switch capacitance,  $V_{CC}$  = supply voltage.

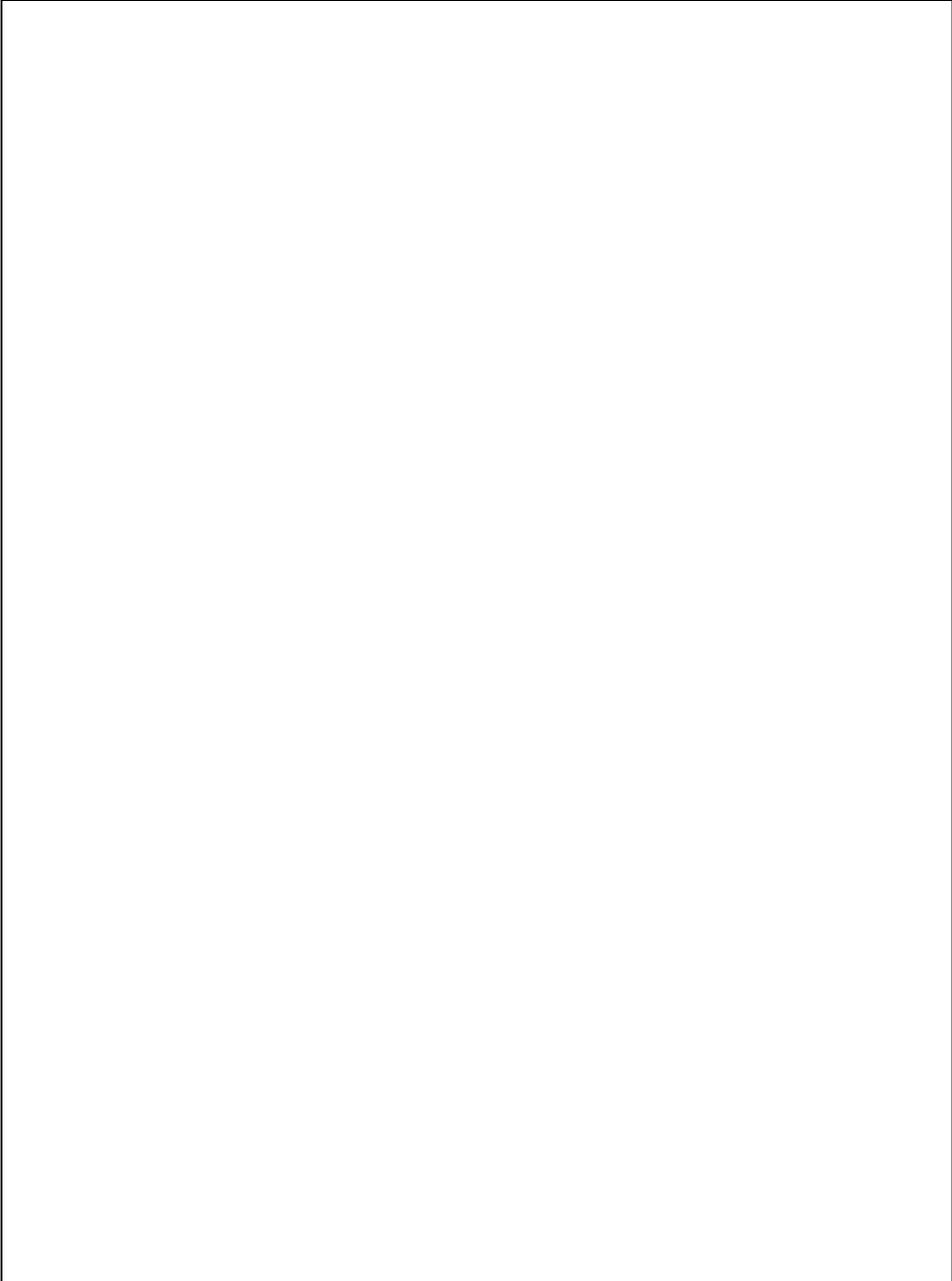

# CD74HC4067, CD74HCT4067

## Analog Channel Specifications $T_A = 25^\circ\text{C}$

PARAMETER	TEST CONDITIONS	V <sub>CC</sub> (V)	HC/HCT	UNITS
Switch Frequency Response Bandwidth at -3dB (Figure 2)	Figure 4, Notes 8, 9	4.5	89	MHz
Sine Wave Distortion	Figure 5	4.5	0.051	%
Feedthrough Noise E to Switch	Figure 6, Notes 9, 10	4.5	TBE	mV
Feedthrough Noise S to Switch			TBE	mV
Switch "OFF" Signal Feedthrough (Figure 3)	Figure 7	4.5	-75	dB
Switch Input Capacitance, C <sub>S</sub>		-	5	pF
Common Capacitance, C <sub>COM</sub>		-	50	pF

**NOTES:**

8. Adjust input level for 0dBm at output,  $f = 1\text{MHz}$ .
9.  $V_{IS}$  is centered at  $V_{CC}/2$ .
10. Adjust input for 0dBm at  $V_{IS}$ .

## Typical Performance Curves

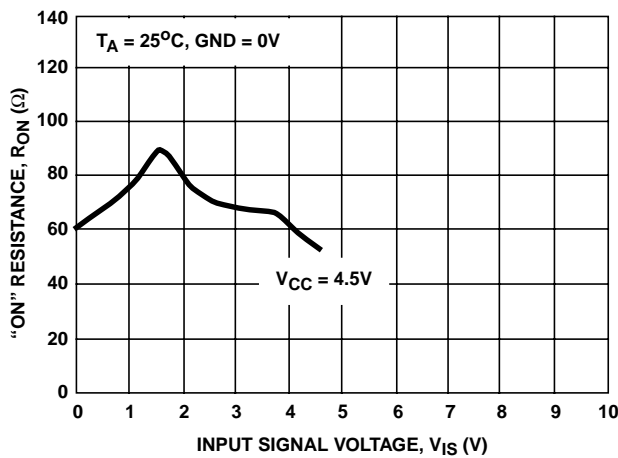

FIGURE 1. TYPICAL "ON" RESISTANCE vs INPUT SIGNAL VOLTAGE

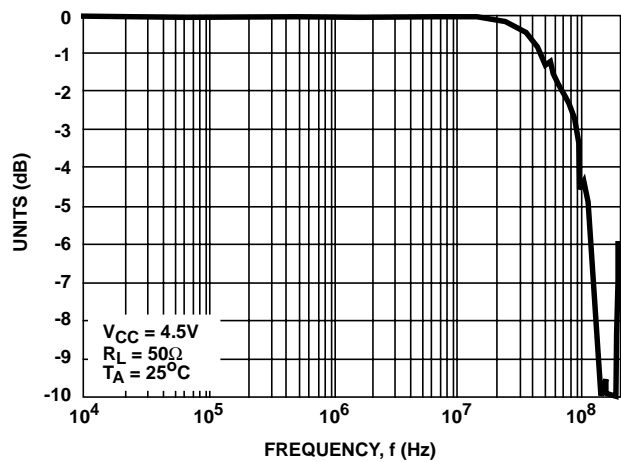

FIGURE 2. TYPICAL SWITCH FREQUENCY RESPONSE

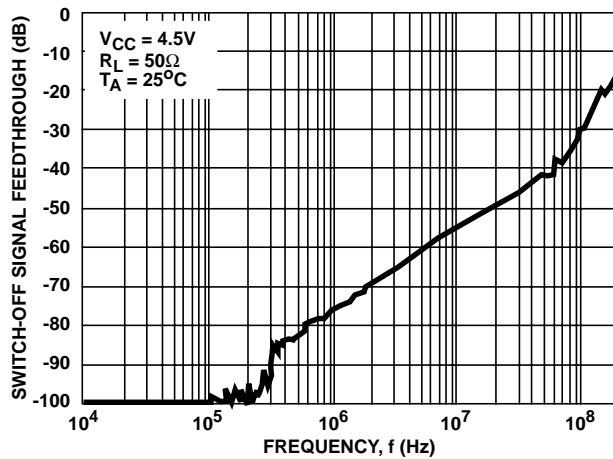

FIGURE 3. TYPICAL SWITCH-OFF SIGNAL FEEDTHROUGH vs FREQUENCY

## Analog Test Circuits

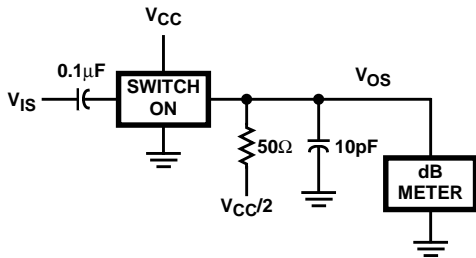
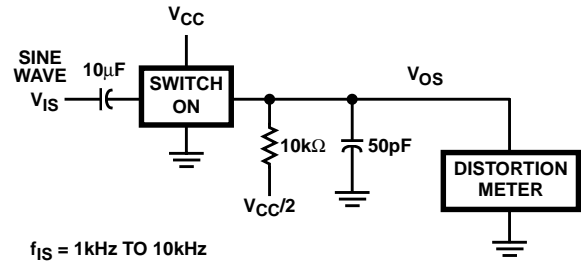

FIGURE 4. FREQUENCY RESPONSE TEST CIRCUIT



$f_{IS} = 1\text{kHz TO } 10\text{kHz}$

FIGURE 5. SINE WAVE DISTORTION TEST CIRCUIT

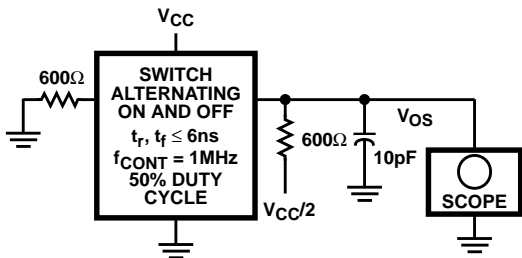

FIGURE 6. CONTROL-TO-SWITCH FEEDTHROUGH NOISE TEST CIRCUIT

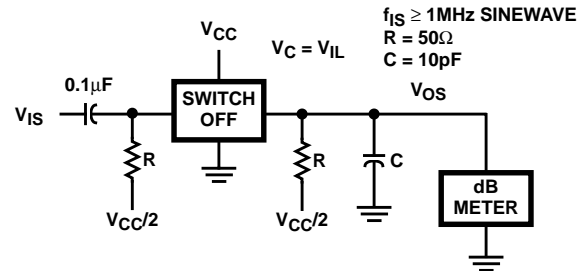

FIGURE 7. SWITCH OFF SIGNAL FEEDTHROUGH TEST CIRCUIT

## Test Circuits and Waveforms

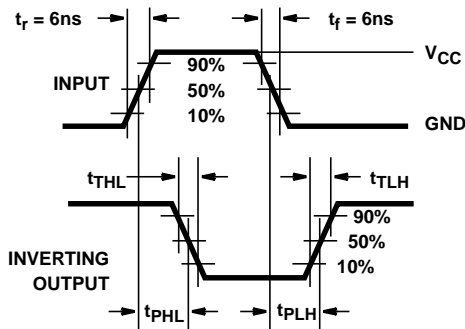

FIGURE 8. HC TRANSITION TIMES AND PROPAGATION DELAY TIMES, COMBINATION LOGIC

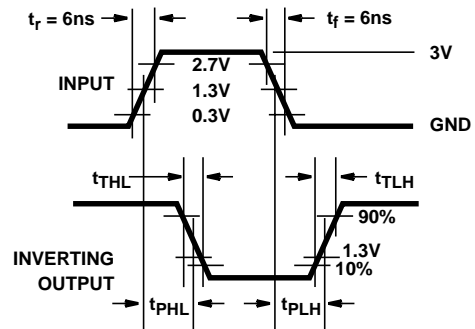

FIGURE 9. HCT TRANSITION TIMES AND PROPAGATION DELAY TIMES, COMBINATION LOGIC



## IMPORTANT NOTICE

Texas Instruments and its subsidiaries (TI) reserve the right to make changes to their products or to discontinue any product or service without notice, and advise customers to obtain the latest version of relevant information to verify, before placing orders, that information being relied on is current and complete. All products are sold subject to the terms and conditions of sale supplied at the time of order acknowledgement, including those pertaining to warranty, patent infringement, and limitation of liability.

TI warrants performance of its semiconductor products to the specifications applicable at the time of sale in accordance with TI's standard warranty. Testing and other quality control techniques are utilized to the extent TI deems necessary to support this warranty. Specific testing of all parameters of each device is not necessarily performed, except those mandated by government requirements.

CERTAIN APPLICATIONS USING SEMICONDUCTOR PRODUCTS MAY INVOLVE POTENTIAL RISKS OF DEATH, PERSONAL INJURY, OR SEVERE PROPERTY OR ENVIRONMENTAL DAMAGE ("CRITICAL APPLICATIONS"). TI SEMICONDUCTOR PRODUCTS ARE NOT DESIGNED, AUTHORIZED, OR WARRANTED TO BE SUITABLE FOR USE IN LIFE-SUPPORT DEVICES OR SYSTEMS OR OTHER CRITICAL APPLICATIONS. INCLUSION OF TI PRODUCTS IN SUCH APPLICATIONS IS UNDERSTOOD TO BE FULLY AT THE CUSTOMER'S RISK.

In order to minimize risks associated with the customer's applications, adequate design and operating safeguards must be provided by the customer to minimize inherent or procedural hazards.

TI assumes no liability for applications assistance or customer product design. TI does not warrant or represent that any license, either express or implied, is granted under any patent right, copyright, mask work right, or other intellectual property right of TI covering or relating to any combination, machine, or process in which such semiconductor products or services might be or are used. TI's publication of information regarding any third party's products or services does not constitute TI's approval, warranty or endorsement thereof.